

# Receptacle Control Solutions

For automatic receptacle control in commercial applications

## Single room



PowPak® relay module

## Whole floor

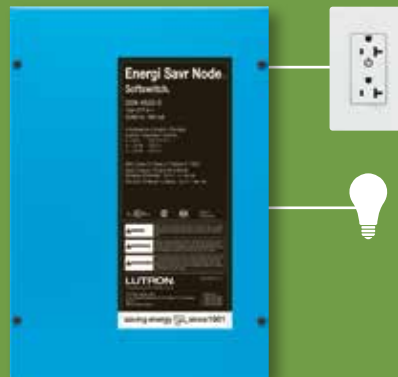

Energi Savr Node™

## Whole building

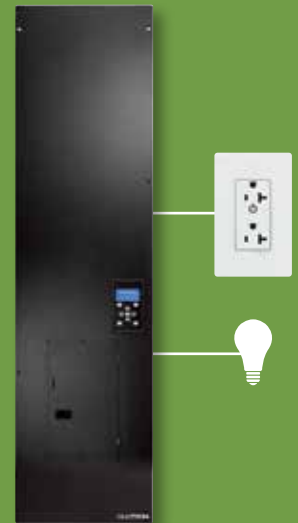

Switching panel with XP module

- **Meet new automatic receptacle control requirements**

- California Title 24 2013
- ASHRAE 90.1 2010

- **Controls receptacles and 120V/277V lighting loads from the same device**

- **Easily expand systems by adding Quantum® functionality to control multiple floors, a whole building, or an entire campus**

- **Meet requirements:**

- UL20 (for general use switches)
- NEMA 410
- UL2043 plenum rated
- UL244A/UL508 Industrial Control Equipment or UL916 Energy Management Equipment

- **For more information:**

[www.lutron.com/energycodes](http://www.lutron.com/energycodes)



# Understanding the Code Requirements

Plug loads are now the third highest contributor to electricity usage in most office buildings, and this is expected to increase as more occupants use personal computers and other electronics.

The new codes are designed to automatically reduce electricity use in unoccupied spaces by requiring automatic receptacle control for 50% of the receptacles in commercial buildings.

## California Title 24 2013

### Circuit control is required for 125V receptacles

Applications: private offices, open office areas, reception areas/lobbies, conference rooms, kitchenettes in office areas, copy rooms

- At least one controlled receptacle within 6 feet of each uncontrolled receptacle (can be split-wired with one plug controlled and one not controlled)
  - Occupancy sensing required for private offices, conference rooms, and multi-purpose areas (lobbies, kitchenettes, copy centers) less than 1,000 square feet.
  - Timeclock with max override of 2 hours also allowed for open offices and multi-purpose areas greater than 1000 square feet
  - Plug-in strips or devices cannot be used for compliance
- 

## ASHRAE 90.1-2010

### Automatic receptacle control is required for 125V receptacles (15 and 20 A)

Applications: private offices, open office areas (including modular partition receptacles), and computer classrooms

- 50% of all receptacles must be controlled
- Occupancy sensing or timeclock controls can be used for compliance
- Plug-in strips or devices cannot be used for compliance – the receptacle shall be controlled and not the plug-in loads

Energy requirements for controlling 50% of the receptacles in commercial buildings can be achieved in two different ways:

- **Split-wired receptacles** (shown in Diagram 1)—one plug on each receptacle is controlled
- **Duplex receptacle** (shown in Diagram 2)—one receptacle within 6 feet of each uncontrolled receptacle is controlled

**Diagram 1: Split-wired Duplex Receptacle**

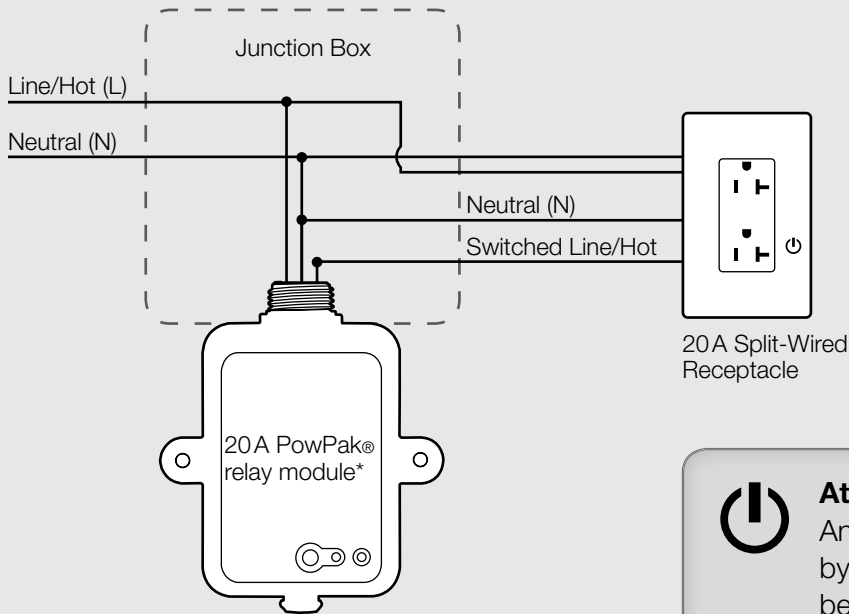

**⏻ Attention Installer**  
 Any receptacles that are controlled by an automatic control device must be marked with “⏻” located on the controlled receptacle outlet where visible after installation as stated in 2014 NEC® Article 406.3(E).

**Diagram 2: Duplex Receptacle**

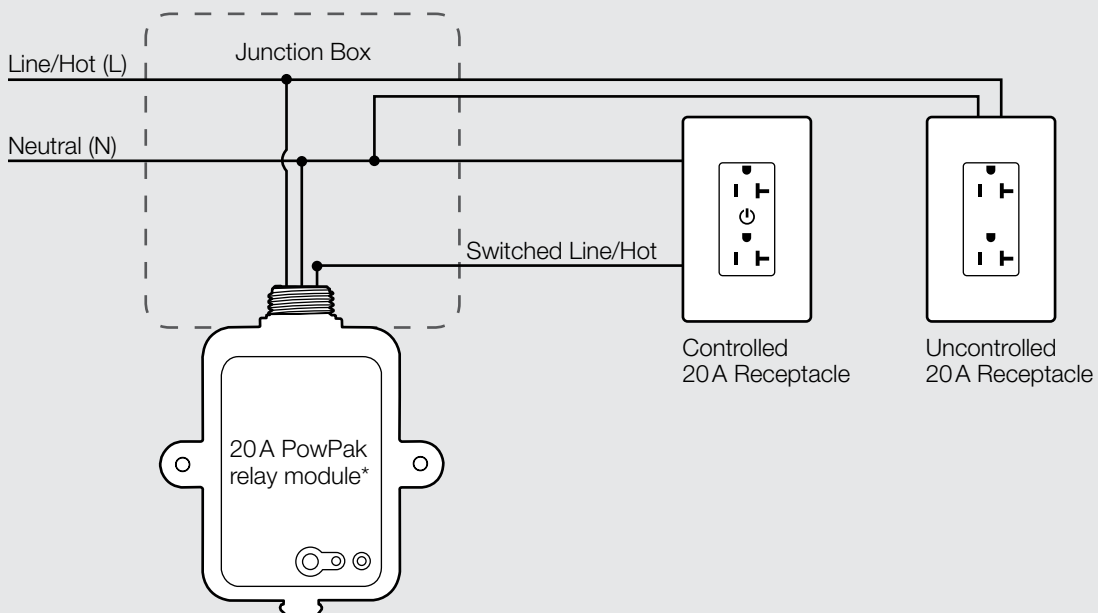

\* Note: The 20A Relay Module is also capable of controlling 120–277 V~ lighting or receptacles. Receptacle wiring diagram shown.

# Lutron Receptacle Control Solutions

Lutron 20A receptacle controllers deliver a range of solutions from single circuit to whole building control, to meet both Title 24 2013 and ASHRAE 90.1 2010 requirements. Lutron solutions are also uniquely able to provide both lighting and receptacle control from a single device.

## Single circuit solution – 20A PowPak® relay module

Lutron 20A PowPak relay modules offer wireless control with simple button-press programming.

- Junction box mounted wireless controller provides control of one 20A circuit
- Communicates with Lutron occupancy/vacancy sensors and Pico® wireless controls via Clear Connect® wireless technology
- Use as a simple, standalone solution for receptacle control or incorporate into an Energi TriPak® lighting control system



## Multi-circuit solution – 20A Energi Savr Node with SoftSwitch®

Control up to four 20A receptacle or lighting (120V/277V) circuits from the same module with no additional equipment required.

- Control receptacles via wired or wireless occupancy/vacancy sensors or personal controls, or via timeclock scheduling
- Lutron patented SoftSwitch technology extends the average life of the relay
- 0-10V model option also available for applications requiring receptacle control and 0-10V dimming of lighting loads
- Use as a standalone, single-area solution or integrate into a Quantum® Total Light Management™ solution



## Panel-based Solution – XP switching module

Control up to 48 receptacle or lighting (120V/277V) circuits with new 20A XP switching modules.





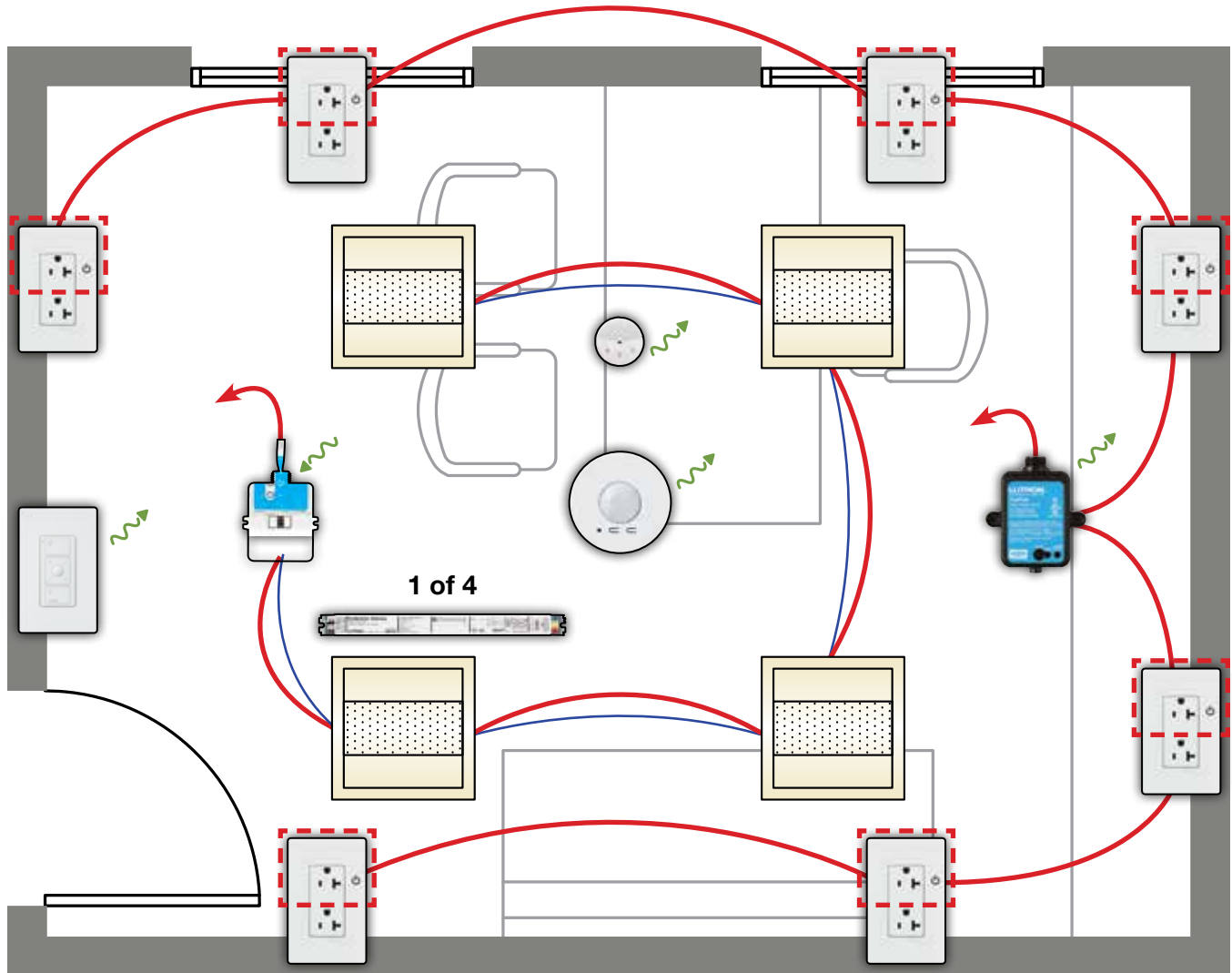

- Control receptacles via wired or wireless occupancy/vacancy sensors or personal controls, or via timeclock scheduling
- Lutron patented SoftSwitch® technology extends the average life of the relay
- Modules are available for use in standalone XPS or LCP128 systems or as part of XP or CCP utilized in Quantum®



# Private Office – 20A PowPak® Relay Module



— Line voltage wiring     
 — Low voltage wiring     
 ~ Clear Connect® RF Communication     
   Split-wired duplex receptacle

| Product   | Quantity | Description                                       | Model Number     |
|---|----------|---|------------------|
|  | 4        | EcoSystem® H-Series ballast                       | EHDT832MU210     |
|  | 1        | 20A PowPak relay module                           | RMJ-H20R-DV-B    |
|  | 1        | PowPak dimming module with EcoSystem              | RMJ-ECO32-DV-B   |
|  | 1        | Radio Powr Savr™ vacancy sensor, ceiling-mount    | LRF2-VCR2B-P-WH  |
|  | 1        | Radio Powr Savr daylight sensor                   | LRF2-DCRB-WH     |
|  | 1        | Pico® wireless control, 3-button with raise/lower | PJ2-3BRL-GWH-L01 |
|   | 1        | Pico wallbox adapter                              | PICO-WBX-ADAPT   |
|   | 1        | Claro® wallplate, 1-gang                          | CW-1-WH          |

## Sequence of operations

---

### Lights

- All lights are dimmable
- The maximum light level has been set to 80%

### Occupancy

- 1 Lights do not automatically turn on when an occupant enters the space; lights must be turned on manually
- 2 Lights turn off automatically 15 minutes after occupants leave the space
- 3 Controlled receptacles turn on automatically when an occupant enters the space
- 4 Controlled receptacles turn off automatically 15 minutes after occupants leave the space

### Daylight

- Lights are controlled by the daylight sensor and automatically brighten and dim to maintain the required light level in the space based on amount of daylight existing in the space

### Wall light control

- Programmed to all of the lights and provides ON/OFF control, BRIGHTEN/DIM control, and allows for one preset level

## Lighting control strategies

---

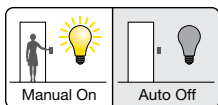

**Occupancy/Vacancy Sensing**

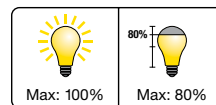

**High-End Trim/Tuning**

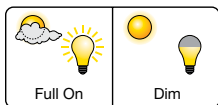

**Daylight Harvesting**

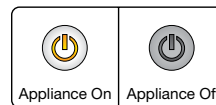





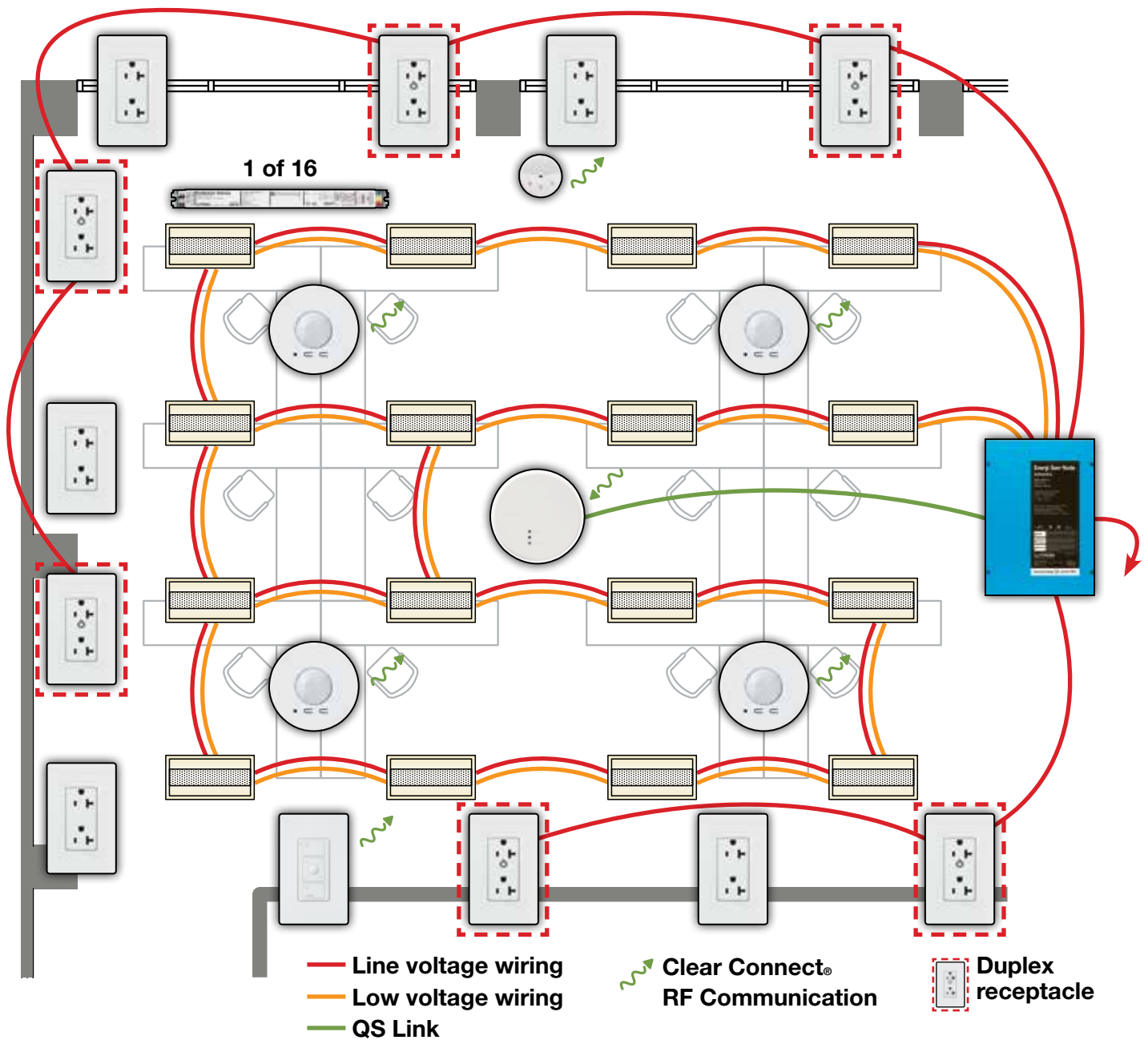

**Plug Load Control**

Note: A single vacancy sensor can be used in each space to operate the lights in vacancy mode while operating the receptacles in occupancy mode. Example shows vacancy control to illustrate the most stringent code compliance. Occupancy sensing can be used to turn lights on automatically depending on the prevailing code.

# Single area solution – open office



| Product   | Quantity | Description                                       | Model Number     |
|---|----------|---|------------------|
|  | 16       | 2-lamp 0–10V ballast by others                    | N/A              |
|  | 1        | 20A Energi Savr Node™ for 0–10V                   | QSN-4T20-S       |
|  | 1        | QS sensor module                                  | QSM2-4W-C        |
|  | 4        | Radio Powr Savr™ vacancy sensor, ceiling mount    | LRF2-VCR2B-P-WH  |
|  | 1        | Radio Powr Savr daylight sensor                   | LRF2-DCRB-WH     |
|  | 1        | Pico® wireless control, 3-button with Raise/Lower | PJ2-3BRL-GWH-L01 |
|   | 1        | Pico wallbox adapter                              | PICO-WBX-ADAPT   |
|   | 1        | Claro® wallplate, 1-gang                          | CW-1-WH          |



# Sequence of operations

---

## Lights

- All lights are dimmable
- The maximum light level has been set to 80%

## Occupancy

- 1 Lights do not automatically turn on when an occupant enters the space; lights must be turned on manually
- 2 Lights turn off automatically 15 minutes after occupants leave the space
- 3 Controlled receptacles turn on automatically when an occupant enters the space.
- 4 Controlled receptacles turn off automatically 15 minutes after occupants leave the space

## Daylight

- Lights are controlled by the daylight sensor and automatically brighten and dim to maintain the required light level in the space

## Wall light control

- Programmed to all of the lights and provides ON/OFF control, BRIGHTEN/DIM control, and allows for one preset level

# Lighting control strategies

---

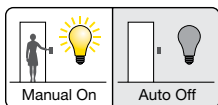

**Occupancy/Vacancy Sensing**

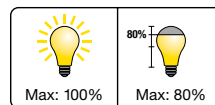

**High-End Trim/Tuning**

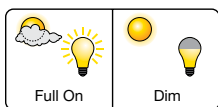

**Daylight Harvesting**

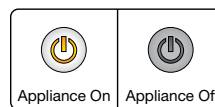

**Plug Load Control**

Note: A single vacancy sensor can be used in each space to operate the lights in vacancy mode while operating the receptacles in occupancy mode. Example shows vacancy control to illustrate the most stringent code compliance. Occupancy sensing can be used to turn lights on automatically depending on the prevailing code.

# Whole floor solution—XP Panel in Quantum

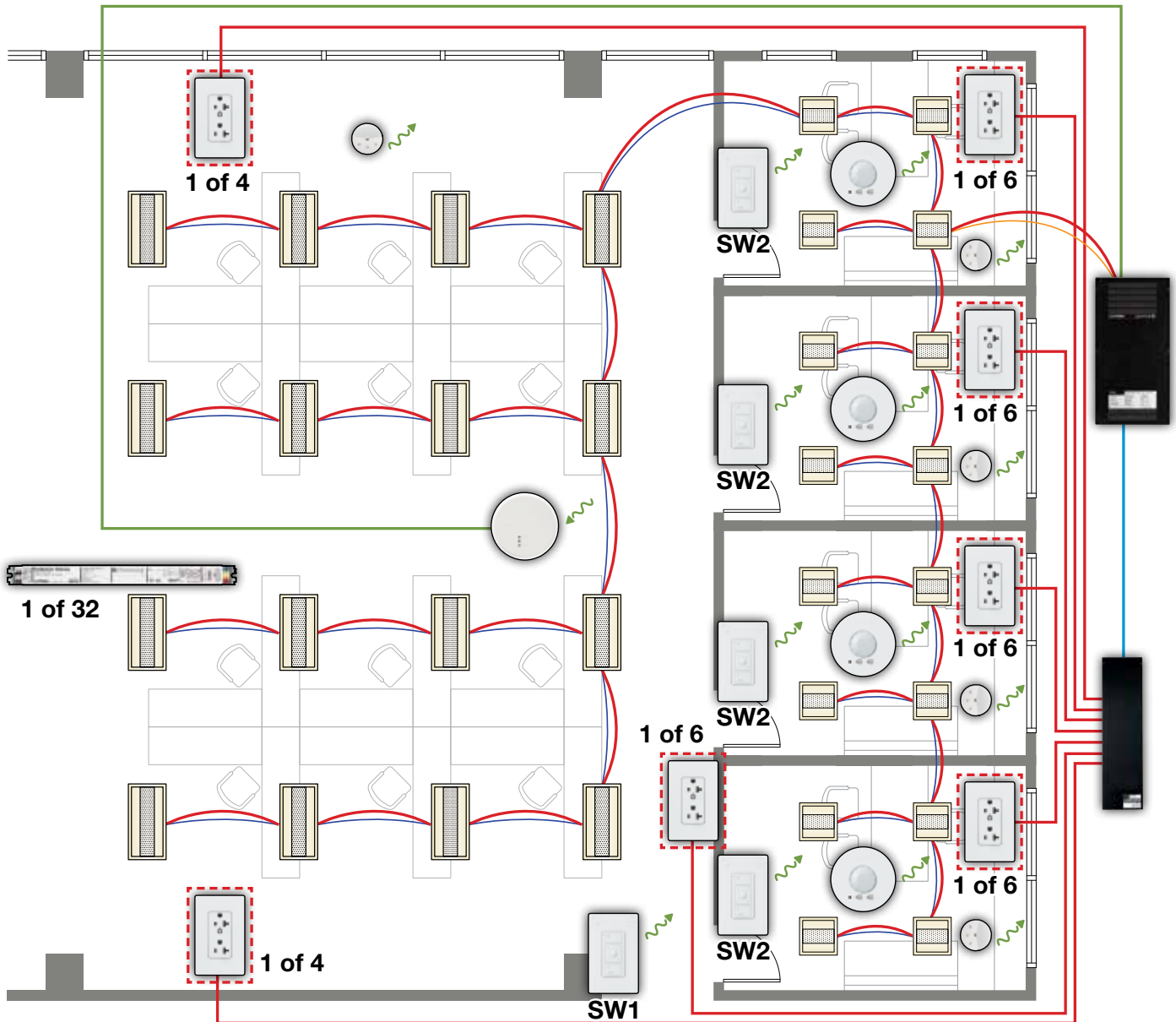

- Line voltage wiring
- Panel link
- Low voltage wiring
- QS Link
- Clear Connect® RF Communication
- Duplex receptacle

| Product | Quantity | Description   | Model Number     |
|---------|----------|---|------------------|
|         | 1        | 24-circuit XP feed-through switching panel              | XP24-FT          |
|         | 1        | Quantum® light management hub with two EcoSystem® loops | QP2-1P2CSE-120   |
|         | 32       | EcoSystem H-Series ballasts                             | EHDT832MU210     |
|         | 1        | QS sensor module  | QSM2-4W-C        |
|         | 4        | Radio Powr Savr™ vacancy sensor, ceiling mount          | LRF2-VCR2B-P-WH  |
|         | 5        | Radio Powr Savr daylight sensor                         | LRF2-DCRB-WH     |
|         | 5        | Pico® wireless control, 3-button with Raise/Lower       | PJ2-3BRL-GWH-L01 |
|         | 5        | Pico wallbox adapter                                    | PICO-WBX-ADAPT   |
|         | 5        | Claro® wallplate, 1-gang                                | CW-1-WH          |

# Sequence of operations

## Lights

- All lights are dimmable
- The maximum light level has been set to 80%

## Occupancy (Private Office)

- 1 Lights do not automatically turn on when an occupant enters the space; lights must be turned on manually
- 2 Lights turn off automatically 15 minutes after occupants leave the space
- 3 Controlled receptacles turn on automatically when an occupant enters the space
- 4 Controlled receptacles turn off automatically 15 minutes after occupants leave the space

## Timeclock (Open Office)

- A timeclock is programmed to schedule “working hours” periods and “off hours” periods on a weekly basis and for holidays
- At the beginning of “off hours” periods, the lights will “blink warn” and then turn off after a 5 minute delay. The receptacles will also turn off after the 5 minute delay; however, the receptacles will not “blink warn.”
- During the “off hours” period, lights and receptacles can be manually overridden with the wall light switch (SW1) for a period of up to 2 hours. After 2 hours the timeclock will “blink warn” the lights and turn off the lights and receptacles after a 5 minute delay.
- During “working hours,” lights can be manually controlled by the wall light switch (SW1); receptacles will remain on

## Daylight

- Lights are controlled by the daylight sensor and automatically brighten and dim to maintain the required light level in the space based on amount of daylight entering the space

## Wall light switch

- SW1 is programmed to all of the lights and receptacles in the Open Office and provides ON/OFF control, BRIGHTEN/DIM control, and allows for one preset level
- SW2 is programmed to all of the lights in each of the Private Offices and provides ON/OFF control, BRIGHTEN/DIM control, and allows for one preset level

## Demand response

- Lights are dimmed 80% of their current level

# Lighting control strategies

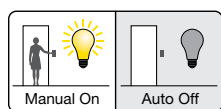

**Occupancy/Vacancy Sensing**

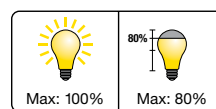

**High-End Trim/Tuning**

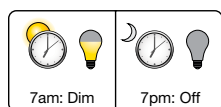

**Scheduling**

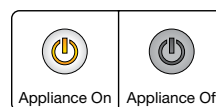

**Plug Load Control**

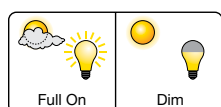

**Daylight Harvesting**

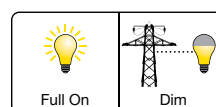



**Demand Response**

Note: A single vacancy sensor can be used in each space to operate the lights in vacancy mode while operating the receptacles in occupancy mode. Example shows vacancy control to illustrate the most stringent code compliance. Occupancy sensing can be used to turn lights on automatically depending on the prevailing code.

## Receptacle controller ordering information

### PowPak® Relay Module

| Product   | Description                                    | Model Number  | List Price |
|---|--|---------------|------------|
|  | 16A PowPak relay module, j-box mount, 120–277V | RMJ-16R-DV-B  | \$109.00   |
|  | 20A PowPak relay module, j-box mount, 120–277V | RMJ-H20R-DV-B | \$300.00   |

### Energi Savr Node™ and XP Switching Modules

Please contact your local Lutron representative for price and availability.

#### **WARNING** — Entrapment/Fire Hazard

To avoid the risk of entrapment, serious injury, or death, these controls must not be used to control equipment which is not visible from every control location or which could create hazardous situations such as entrapment if operated accidentally. Examples of such equipment which must not be operated by these controls include (but are not limited to) motorized gates, industrial doors, space heaters, etc. It is the installer's responsibility to ensure that the equipment being controlled is visible from every control location and that only suitable equipment is connected to these controls. Failure to do so could result in serious injury or death.